

EMpower System Troubleshooting Guide



Equipment Failure to start	2
Equipment Unexpected turn off	3
No SD Card	4
SD CARD Wrong Format	5
SD CARD format is not compatible with the Receiver OS ..	6
SD Card Read Only	7
GPS Not Detected	8
Failure to Record	9
SD Card is Full	10
Configuration file issues	11
Invalid Configuration Network	12
Remote Control Problem Connection	13
Connection Problems	14
Cable Not Detected	15
Channels Damaged / Not Found	16
License Activation	17
Unusual Contact Resistance	18
Magnetic Sensor Detection	19
Sensor Calibration warning	20
Recording - Sensor problem	21
Saturated Frames	22
Bad Records	23
Instrument Health	24
Missing Sensor Calibration	25
Bad PNT curve	26
Technical Support Contact	27

Equipment Failure to start

Problem:

1. The **Power** button blinks Red in a fast sequence
(This indicates a severe problem)
2. **The Power** button blinks Red in a slow sequence and never gets out of that state. The display does not light up and the SD button stays off. The receiver stays like this for more than 10 minutes

Solution:

The receiver needs to be repaired. Please contact Phoenix Geophysics technical support, *(see last page)*



Use the SD button to navigate in the on-screen display

1

Warning



REC ERRORS

=====
TIMING MODULE
FAILURE

2

Warning



SD



Equipment Unexpected turn off

Problem:

Receiver powers on briefly, and powers off right away, or when returning to the site the equipment is off

Solution:

1. Check that the **Battery** measures 12V with a voltmeter after powering on
 - Check the recording details of the last recording to see if the battery voltage reached low levels and turned off the receiver
2. Check if the battery cable is still attached
 - Animals might have chewed through it or disconnected it
 - A damaged cable (internally broken or old) can cause an intermittent power failure during recording
3. The instrument might have gotten too hot and entered protection mode
 - Check the recording details of the last recording to see if the temperature reached invalid levels
4. The instrument might have received a momentary spike of high current through the electric sensor or ground post
 - Check that the **SD Card** is still healthy, and check the last part of the last recording for saturation

Warning



No SD Card

Problem:

When the SD card is not detected

Solution:

1. Turn off the receiver by pressing the Power button down for a few seconds
 - Eject the SD card
 - Clean the SD card / SD card slot of dust or grit if necessary
 - Check the card capacity (64GB - 256GB)
 - Ensure that the card is formatted as **exFat**
 - Re-insert the card

**Use the SD button to navigate the on-screen display*

2. Turn on the receiver by pressing the Power button

Warning

SD 

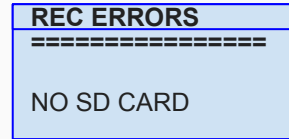

- 1 Press the Power button for >3sec and release

Shutdown Off



- 2 Press Power button briefly and release

Starting Acquiring GPS Ready



Only SD cards supplied by Phoenix are supported. Other SD cards that comply with the SDXC standard may work depending on the card rating and environmental conditions

SD CARD Wrong Format

Problem:

Some SD cards have a format that is not according to the SD association standard. To reduce the risk of data loss and/or bad performance, use genuine SD cards.

How to identify a not genuine SD Card

- The tab slider is yellow
- The sticker has a very low graphic quality

Solution:

Format the SD card (*cards must be in **ExFAT format***)

Check the card capacity (*64GB - 256GB*)

1. Download the SD Memory Card Formatter from <https://www.sdcard.org/downloads/formatter/>
2. Format the card using SD Formatter by selecting the below options
 - Format type - FULL(Overwrite)
 - Size Adjustment - ON

Warning

SD ■■■■■■■■

REC ERRORS

=====
SD CARD IS DAMAGED
CORRUPTED OR
THE WRONG FORMAT



SD CARD format is not compatible with the Receiver OS

Problem:

The receiver could not detect the SD card format, sometimes the formatting will be slightly different based upon the tools used

Solution:

1. Windows/ Mac

- Use SD Memory Card formatter tool to format the SD card
<https://www.sdcard.org/downloads/formatter/>

2. Linux *(The GUI formatting tools available in Linux might not solve this problem properly. We suggest the console-based procedure below)*

⚠ WARNING

Make sure to select the right partition. Use the below commands VERY CAREFULLY otherwise, it could damage the operating system of your computer

Delete the SD card MBR, for example:

- `dd if=/dev/zero of=<sd card block device> bs=512 count=1`
- Use fdisk to create an MBR primary partition using the maximum space available
- Set the partition type to 07
- Write changes to the card MBR
- Format the partition using exFAT (`mkfs.exfat <sd card partition>`)

Warning

SD ■■■■■■■■

REC ERRORS
=====
SD CARD IS DAMAGED
CORRUPTED OR
THE WRONG FORMAT

SD Card Read Only

Problem:

The SD card is set to read only

Solution:

1. Turn off the receiver by pressing the Power button for a few seconds
 - Eject the SD card
 - Move the tab slider up
 - Check that the card is not corrupted by running a Card diagnostic in Windows
 - Re-insert the card

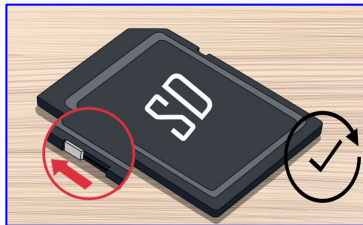

2. Turn on the receiver by pressing the Power button, and review the SD card status on the display

Warning

SD ■■■■■■

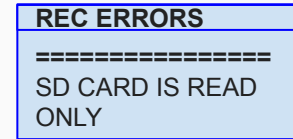

Use the SD button to navigate in the on-screen display

- 1 Press the Power button for >3sec and release



- 2 Press the Power button briefly and release



If the problem persists, the card might be damaged and might need to be re-formatted as exFat or replaced

GPS Not Detected

Problem:

In most cases, the Receiver takes only a few minutes to synchronize to the GPS signal. However, under certain conditions, the synchronization could take longer (*see info note below*). Meanwhile the warning **"GPS: 0 [--]"**, appears on the receiver display.

Solution:

1. Reposition the antenna for a clear view of the sky
 - o Check the condition of the GPS antenna cable, and replace it if damaged
 - o Ensure that there is a clear line-of-sight between the GPS antenna and the sky
 - o Test with an antenna and cable from another receiver
2. Wait until the Power button turns blue



This could happen if the receiver has been turned off for several days. In this case, the Receiver needs to re-acquire the satellite almanac. This may take up to 12 minutes.

Warning



Instrument Status

Mode: Idle
Temp: [C]
GPS: 0 [--]
Batt: [V]: 11.99
SD Use: 0.1/64 GB



Use the SD button to navigate in the on-screen display

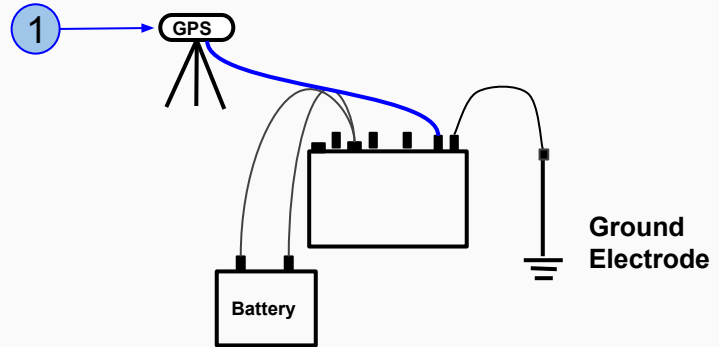

SD

Starting



Acquiring GPS



Ready



Failure to Record

Problem:

When returning to pick up the equipment, the receiver is on, but not recording

Solution:

1. Review the display
 - Make sure that a calibration configuration file was not used by mistake
2. Check to see if the SD card ran out of space
 - Check the LED indicators for this condition (*see the next page*)
3. Check your configuration file and ensure that there were no schedules that could have stopped the recording



SD Card is Full

Problem:

When the SD card is full

Solution:

1. Turn off the receiver

- Eject the SD card
- Open the configuration file in the Configuration creator to calculate the space required by the recording program

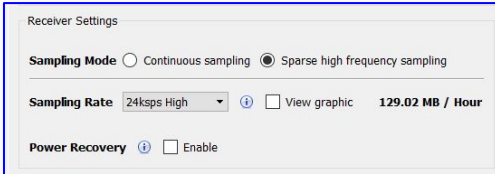

- Use the file browser to ensure there is enough space available in the SD card
- If necessary, archive old data to a computer or an external device and delete the copy on the card
- Re-insert the SD card

2. Turn on the receiver

Warning

SD 

REC ERRORS

=====
SD CARD FULL

- 1 Press the Power button for >3sec and release



- 2 Press the Power button briefly and release



The card will never be filled to the end. There is a protection buffer kept to prevent equipment failure, and its size depends on the decimation scheme. If there is less than 500MB available on the card, free up more space.

Configuration File Issues

Problem:

A valid configuration file can not be found, or the information is incorrect

Solution:

1. Turn off the receiver

- Eject the SD card
- Review the configuration file in EMpower to ensure that the receiver type matches the receiver where the SD card is being inserted
- Verify the SD card health by running an SD card diagnostic/repair tool in Windows. Ensure that the card is ≥ 64 GB and has the same type of format as it came from the factory (exFat)
- Re-insert the SD card

2. Turn on the receiver

Warning



REC ERRORS
=====

INVALID CONFIG RECEIVER TYPE INCOMPATIBLE

REC ERRORS
=====

INVALID CONFIG MALFORMED FILE

REC ERRORS
=====

NO CONFIG FILE IN THE SD CARD

1 Press the Power button for >3sec and release

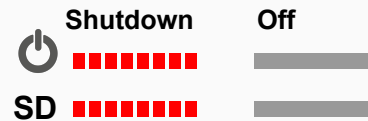

2 Press power button briefly and release

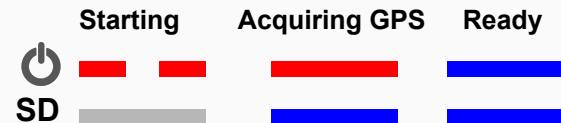

Invalid Network Configuration

Problem:

When the Network configuration on the configuration file is not proper or corrupted, the receiver will report this warning

Solution:

Review the configuration file

1. Open EMpower

2. Prepare module

- Select the receiver and the Recording

3. Load the Configuration file from the SD Card

- Review the Networking Settings information

Warning

SD ■ ■

REC ERRORS

INVALID CONFIG
NETWORK
SETTINGS INVALID

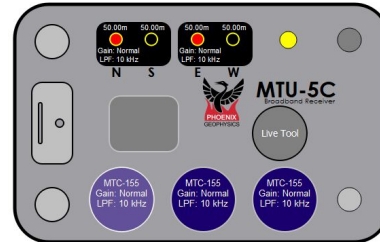
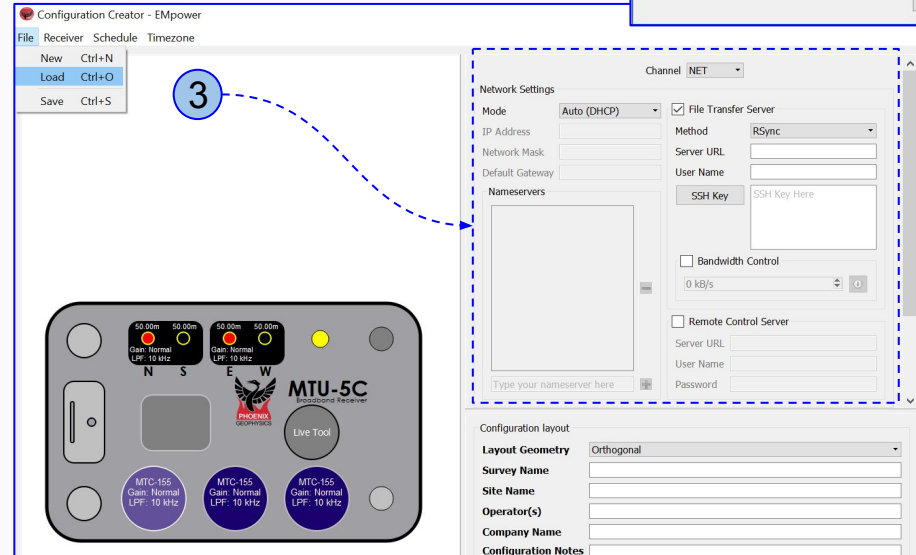
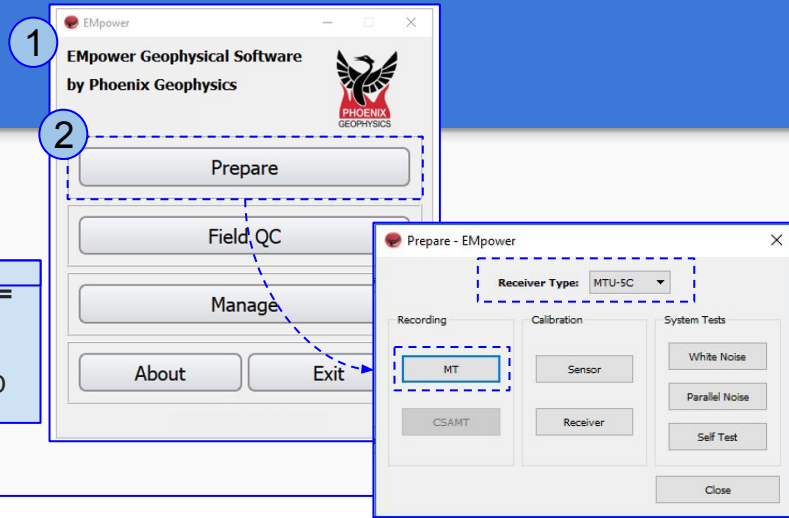

Connection Problems - Remote Instrument Control

Problem:

When you are attempting to send a command to a receiver from the EMpower **Remote Control Client**, the connection is not successful these messages may be displayed

Suggestion:

1. Check that the connection information including credentials (if used) is correct
2. Ensure that you are connected to the Internet
3. Check that there are no firewalls or other mechanisms preventing the connection to the MQTT server

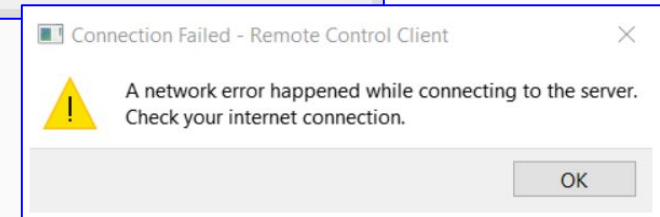
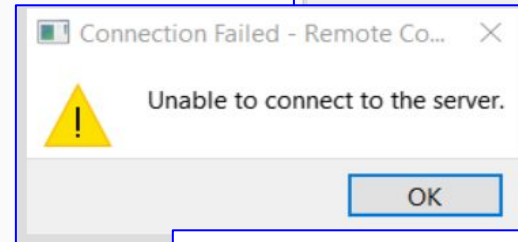
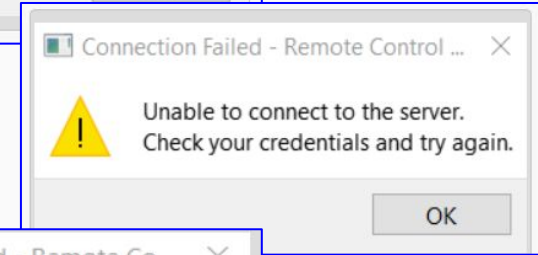
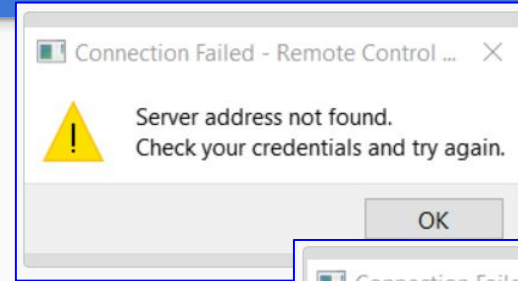

Connection Problems - Remote File Upload

Problem:

Receiver can not connect to the server to transfer files

Ping: **Timeout**

Ping: **DNS Error**

Solution:

1. Turn off the receiver

2. Eject the SD card

- Review the Networking Settings on the configuration file in EMpower. Review that the server URL works correctly by trying to connect to it using a laptop (see page 12)



If the receiver is not able to connect to the server, check the connections and protocols of the Network Configuration

NETWORK STATUS
Mode: Rsync
Cable Connected
Address: 193.168.2.172
Gateway: 193.168.1.1
Ping: Timeout

NETWORK STATUS
Mode: Rsync
Cable Connected
Address: 193.168.2.172
Gateway: 193.168.1.1
Ping: DNS Error

① Press the Power button for >3sec and release

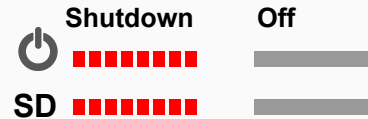

Cable Not Detected

Problem:

The receiver can not detect the cable on the Network port

Solution:

1. Disconnect the cable
2. Review the cable condition
3. Connect the cable
4. Ensure there is no loose connection at both ends of the cable

NETWORK STATUS
Mode: Rsync
Cable Not Detected

Channels Damaged / Not Found

Warning:

The SD LED is flashing red and the screen shows the damaged channel(s) or on boot up.

Solution:

1. Return the receiver to Phoenix to repair the channel(s)
2. Use the working channels to record data
 - Before starting, disable the damaged channel(s) on the Configuration File
 - Connect the sensors to the working channels
 - Start the recording by pressing the Power button
 - *The warning state will continue until the recording starts*
 - Once the recording ends, the SD button will start indicating the state by changing to red

The WARNING screen will still be available by pressing the SD button

Warning

SD ■■■

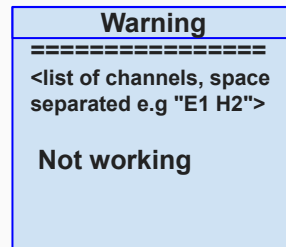

If all of the channels are not working, this will be deemed to be a critical failure, since the receiver will not be able to take any data in that case.

License Activation

Problem:

1. The **Activation code** field has a red **X** at the end

Solution 1:

- Check that the activation code entered matches the code on the license card and try again

Problem:

2. The computer cannot connect to the server to complete the activation process

Solution 2:

- Review the internet connection and try again, if the problem persists contact Phoenix technical support. (see the last page)

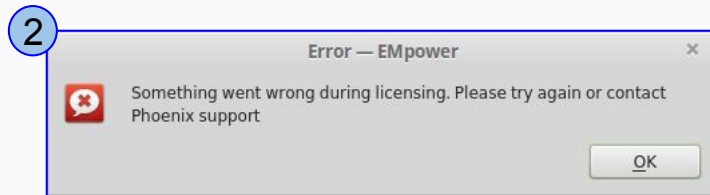
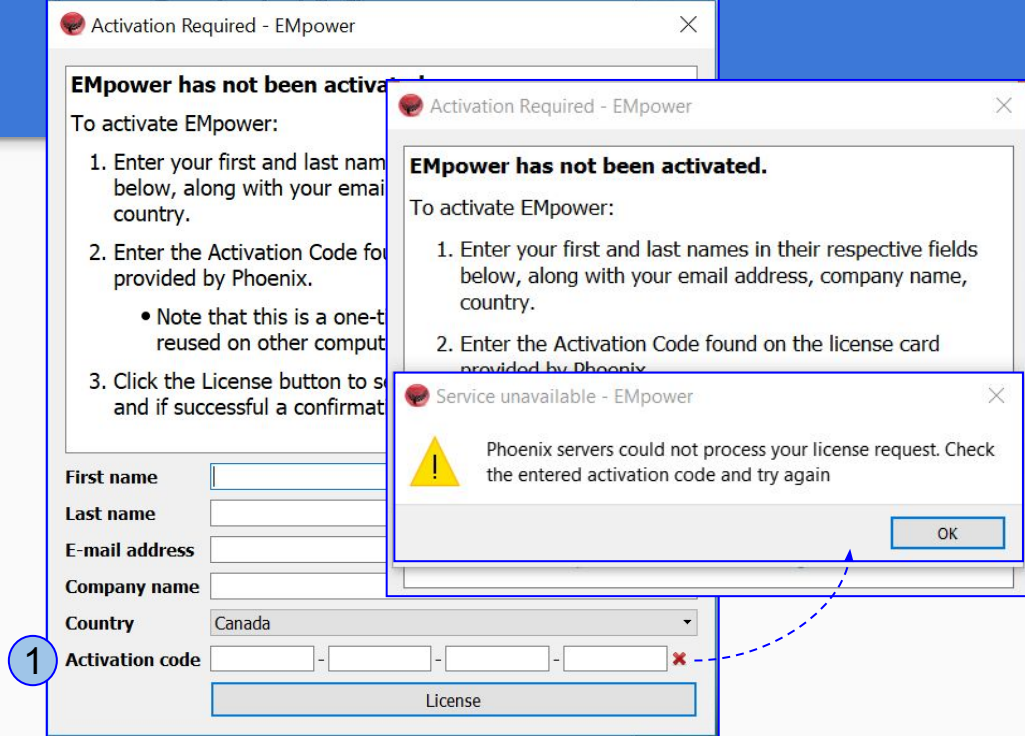

Unusual Contact Resistance

Problem:

The Electric channels show a warning icon when the contact Resistance is out of range

Review:

This might be normal depending on the field conditions. If not, look for broken, frayed, or exposed wires or connections, and any evidence of damage in general

1. Verify the setup

- Make sure the electrode is sitting on a conductive surface (*remove rocks*)

2. If the problem persists, set the electrodes upright in a container with a few centimeters of saltwater or another ion-rich solution and measure the resistance between any pair of electrodes

- The resistance should be $<100 \Omega$
- Measure the DC potential between each electrodes pair
- The self-potential should be $<10 \text{ mV}$
- If the last two points are not in this range the electrodes could be damaged or noisy and need to be replaced

Recording Information

Recording ID: 10065_2015-05-06-185536 ⓘ

⚠ There were warnings detected in E3, E4, E5, H1, H2, H3
View warning icons for more details

Start time: May 06 2015 11:55:37 (Local) Eastern Daylight Time (GPS -07:00)

Duration: 2 h 23 m 50 s

Survey name: Nevada May 2015

Station name: 10065 Site 2

Operator(s): SW + DF

Company name:

Layout Geometry: Orthogonal

Declination: 0.00°

Notes:

Electric Channels

Channel	Distance (m) to GND	(+) N / E	(-) S / W	Polarity	(+) N / E	(-) S / W	Gain	LPF [Hz]	DC [V]
E1	50.00	50.00	<input type="checkbox"/> Inverted		691.321	705.405	4 x 1 = x4	10000	0.0043
E2	50.00	50.00	<input type="checkbox"/> Inverted		675.102	665.761	4 x 1 = x4	10000	0.00031
E3	50.00	50.00	<input type="checkbox"/> Inverted		0.000	0.000	4 x 1 = x4	10000	0

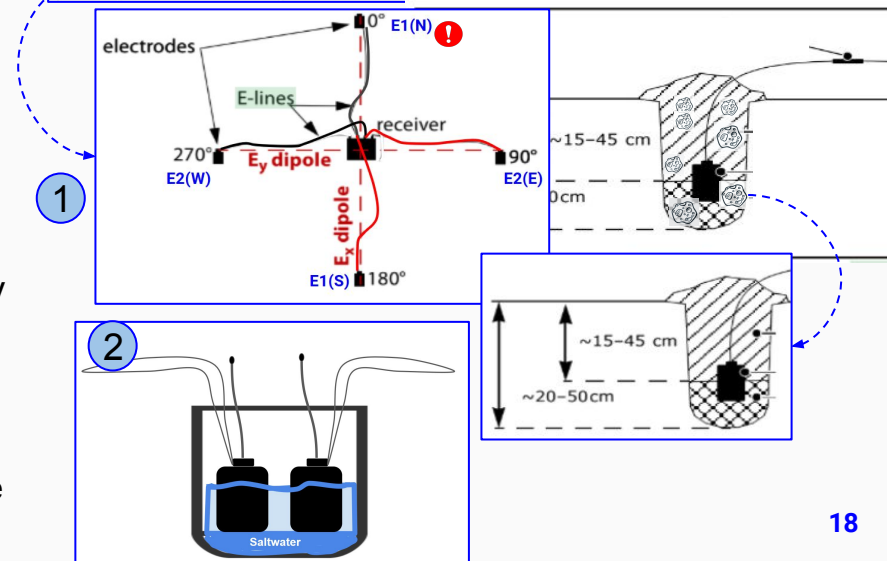

Receiver Warning - Sensor Calibration

! Warning:

During the Sensor Calibration the Power LED flashes red, and the message in the image is shown in the screen of the receiver (this warning is applicable for MTC-155 and MTC-185 sensors)

Possible causes:

- Configured model and detected model don't match
- No serial number was detected
- Sensor not connected

Solution

- Check the config file
 - Ensure that the Sensor type configured matches the sensor type connected to each channel
- Swap the sensor and the connected cable that reported this failure with a sensor and cable of the exact same type that are known to work
 - Contact Phoenix to repair the sensor if the issue follows the sensor.

Warning

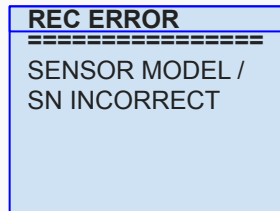

*Note that when several channels are enabled for calibration in the configuration file, the calibration process will stop if **any** of the channels encounters a mismatch of a disconnection*

Receiver Warning - Sensor mismatch

Warning:

During a recording, the receiver reports on the screen a sensor mismatch (it is normal for the receiver to continue recording upon this warning).

Cause:

When the sensor is configured as MTC-155 or MTC-185, the receiver will compare the configured sensor type against the detected sensor and will send a mismatch warning in case of discrepancy. This warning will also appear if the model or serial of the sensor were not autodetected by the receiver, which can happen if the sensor was not connected or the sensor or cable are damaged.

Solution

- Check the config file
 - Ensure that the Sensor type configured matches the sensor type connected to each channel reported on the screen
- To check if the problem comes from a broken sensor or cable, swap the sensor and the connected cable that reported this failure with a sensor and cable of the exact same type that are known to work
 - Contact Phoenix to repair the sensor if the issue follows the sensor.



SD



REC WARNING

```
-----  
H1  
SENSOR  
MODEL / SN  
INCORRECT
```



During a recording, both power and SD LED's will be normal even if there is warning about a sensor mismatch.

The recording will not be interrupted but will show a warning in EMpower (see next page).

EMpower - Magnetic Sensor Detection

⚠ Warning

1. Unknown - The receiver saw signal from the sensor, but there likely was a source of noise near the sensor while the instrument was trying to detect its signature. This recording might still be useful.

Solution

- Check the config file. Ensure that the Sensor Type is correct
- Check the sensor connectors
- Move the sensor to a quieter area

⚠ Warning

2. Sensor mismatch - Sensor detected doesn't match the sensor configured

Solution

- Check the config file. Ensure that the Sensor Type is correct

❗ Error

3. Not Present - No signal was detected. This could be caused by a bad connection, damaged cable and/or the sensor itself.

Solution

- Connect a sensor that was successfully detected by another Instrument to the channel that did not correctly detect the first sensor
- If the fault condition persists in the same receiver channel, please contact our technical support
- If the channel detects the new sensor and the problem follows the coil lead and/or the sensor, replace the coil lead and/or the sensor

1

Channel	Sensor	Detected	Serial #	Polarity
H1	AMTC-30	AMTC-30	2686	<input type="checkbox"/> Inverted
H2	AMTC-30	AMTC-30	2862	<input type="checkbox"/> Inverted
H3	MTC-80H	Unknown	2861	<input type="checkbox"/> Inverted

H1-H3 Azimuth: 0.00 °

2

The following warnings were detected:

- Sensor mismatch
- Detected sensor (MTC-150-?) does not match configured sensor (MTC-80H.)

3

Channel	Sensor	Detected
H1	MTC-80H	MTC-150-?
H2	MTC-155	Not Present
H3	MTC-155	Not Present

H1-H3 Azimuth: 0.00 °

The following warnings were detected:

- No signal detected. Check sensor connection
- Sensor mismatch

❗ *This recording might not contain valid data*

Saturated Frames

Warning:

This critical warning could be caused by a bad connection to the Electrode binding posts of the receiver, high contact resistance of an electrode, noise, or excessive gain. A very small amount of saturation could have been caused by a transient

Solution:

Check the installation of the electrode in the field (See *Unusual Contact Resistance*).

1. Gain "Normal" is designed to get the optimal point between noise versus input range
2. Change for **High** gain, if the saturation is less than 2% to increase input signal range
 - o In case the saturation is more than 2%, check for noise sources (*cable connections, electrodes, etc.*) and try to eliminate them. If the saturation doesn't change, reduce dipole lengths and set a **Low** channel gain as last resort

When saturation is caused by constant external noise, reducing dipole length or channel gain might prevent saturation

**Preference should be given to keeping the preamplifier on and reducing the main channel gain if possible*

Serial Number: 202980 Firmware Version: 00010027X
Model: BTM01-I # of Satellites: 7 - 7 satellites ✓ Details

Channels Details						
	Tag	Board S/N	Model	Firmware	Sat	Signal Ranges
1	E1	200084	BCM01-J	1001d	50.972 % - View	View Levels
2	E2	200062	BCM01-J	1001d	51.472 % - View	View Levels
3	H1	200042	BCM01-J	1001d	0 %	View Levels
4	H2	200073	BCM01-J	1001d	0 %	View Levels
5	H3	200063	BCM01-J	1001d	0 %	View Levels

Close

1

Channel: E1

Electric channel settings

Enabled

Gain: Normal

Low Pass Filter: 10 kHz

Positive Distance: 50.00 m

Negative Distance: 50.00 m

2

Channel: E1

Electric channel settings

Enabled

Gain: High

Low Pass Filter: 10 kHz

Positive Distance: 50.00 m

Negative Distance: 50.00 m

Bad Records

Warning:

The **Recording Information** shows a warning icon by the side of Recording ID (*There is not a solution for this warning*)

Could be caused by:

- Check if the failure occurred while the data was being transferred to the card
- The instrument could have lost data, if the receiver repeats this often, contact Phoenix support (*see the last page*)

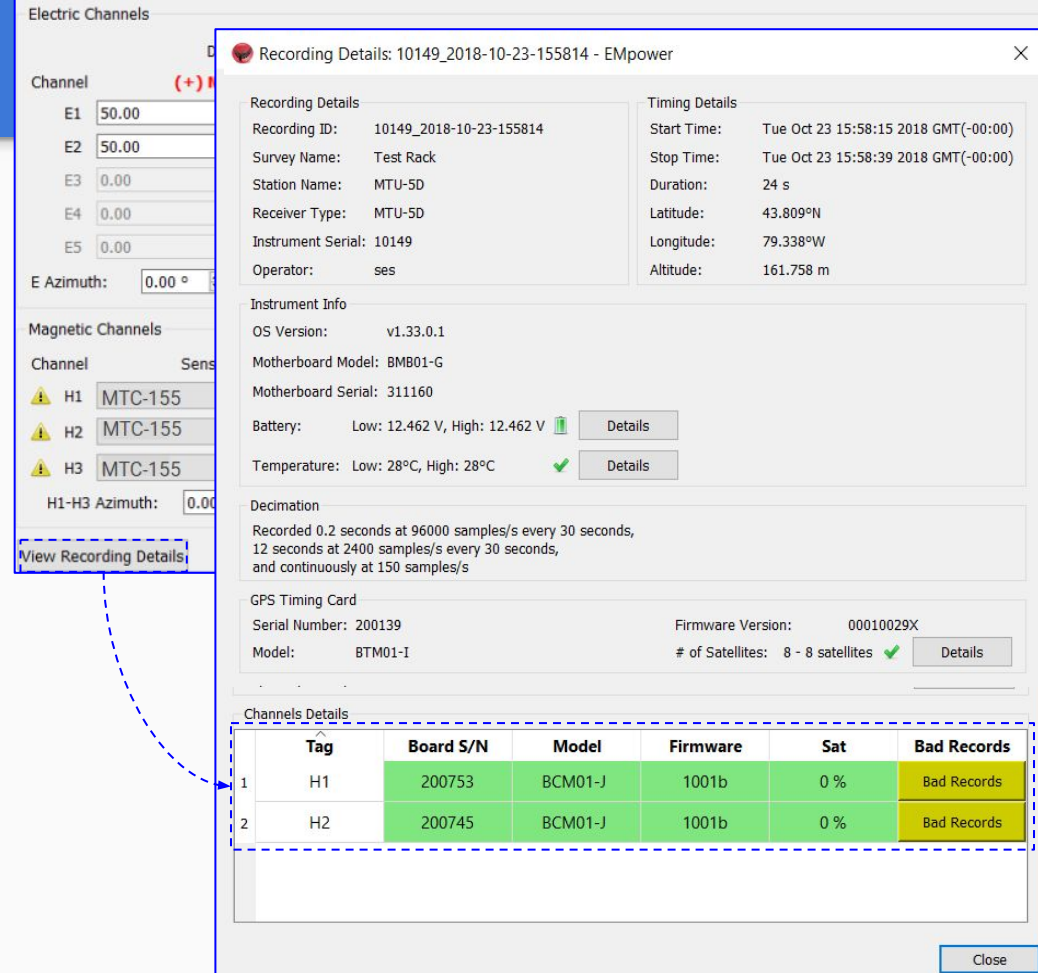

Recording Details: 10149_2018-10-23-155814 - EMpower

Channel: E1 50.00, E2 50.00, E3 0.00, E4 0.00, E5 0.00

E Azimuth: 0.00 °

Magnetic Channels: H1 MTC-155, H2 MTC-155, H3 MTC-155

H1-H3 Azimuth: 0.00

View Recording Details

Recording Details: Recording ID: 10149_2018-10-23-155814, Survey Name: Test Rack, Station Name: MTU-5D, Receiver Type: MTU-5D, Instrument Serial: 10149, Operator: ses

Timing Details: Start Time: Tue Oct 23 15:58:15 2018 GMT(-00:00), Stop Time: Tue Oct 23 15:58:39 2018 GMT(-00:00), Duration: 24 s, Latitude: 43.809°N, Longitude: 79.338°W, Altitude: 161.758 m

Instrument Info: OS Version: v1.33.0.1, Motherboard Model: BMB01-G, Motherboard Serial: 311160, Battery: Low: 12.462 V, High: 12.462 V, Temperature: Low: 28°C, High: 28°C

Decimation: Recorded 0.2 seconds at 96000 samples/s every 30 seconds, 12 seconds at 2400 samples/s every 30 seconds, and continuously at 150 samples/s

GPS Timing Card: Serial Number: 200139, Firmware Version: 00010029X, Model: BTM01-I, # of Satellites: 8 - 8 satellites

Channels Details

	Tag	Board S/N	Model	Firmware	Sat	Bad Records
1	H1	200753	BCM01-J	1001b	0 %	Bad Records
2	H2	200745	BCM01-J	1001b	0 %	Bad Records

Close

Instrument Health

 **Warning:**

This warning symbol may indicate other problems with the instrument's health

Solution:

1. Battery

- Measure the battery voltage before connecting it to the receiver, and again when the equipment is turned on (*both measurements should be 12V minimum*)
- Check the battery electrolyte fluid level and add liquid to it if needed

2. Temperature

- In hot places, protect the receiver with an umbrella and provide good ventilation

3. # of Satellites

- Ensure a clear line-of-sight between the GPS antenna and the sky
- Check for damage to the GPS cable or antenna
- Test the receiver with a GPS antenna and cable from another receiver (*See GPS Not Detected*)

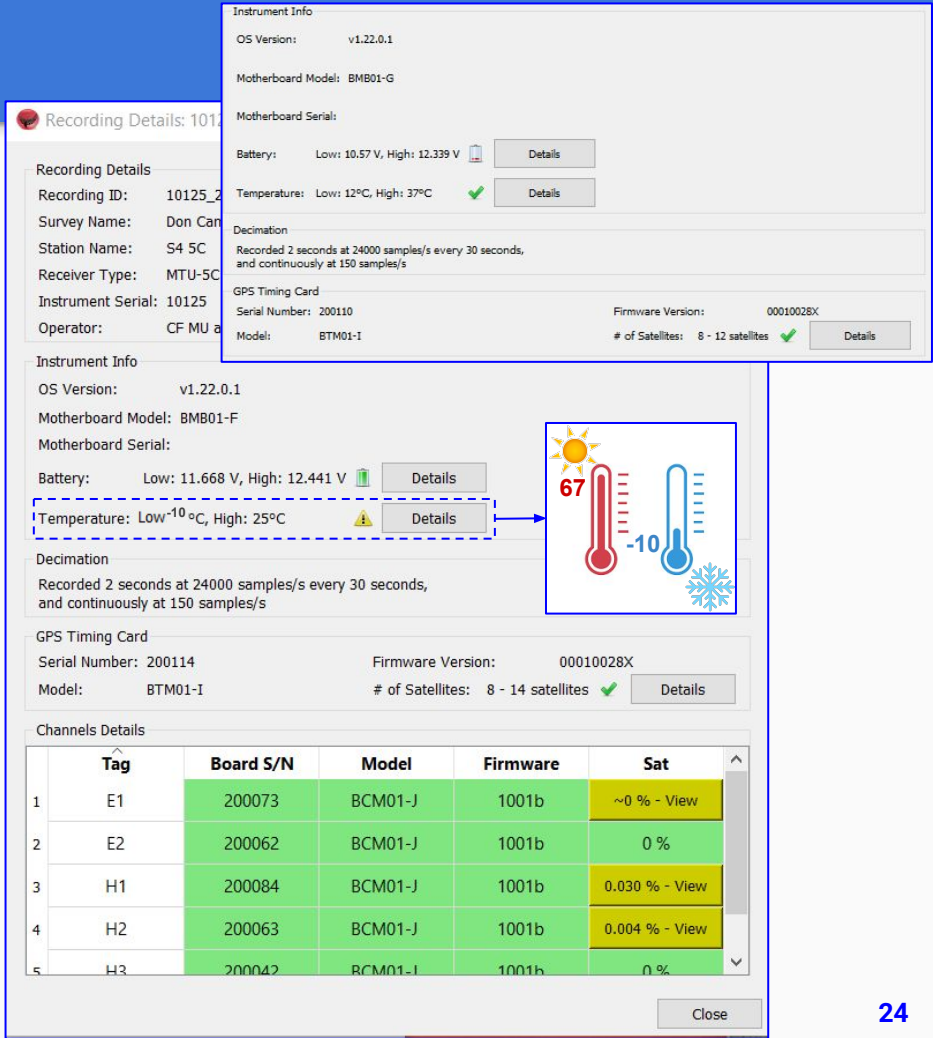

The screenshot displays the 'Recording Details' and 'Instrument Info' sections of a monitoring application. A blue box highlights the 'Temperature' field in the 'Instrument Info' section, which shows a low of -10°C and a high of 25°C, accompanied by a warning icon. An inset image shows a thermometer with a red liquid level at 67 and a blue liquid level at -10, with a sun icon above and a snowflake icon below, indicating a wide temperature range. Below the 'Instrument Info' section is a 'Channels Details' table with the following data:

	Tag	Board S/N	Model	Firmware	Sat
1	E1	200073	BCM01-J	1001b	~0 % - View
2	E2	200062	BCM01-J	1001b	0 %
3	H1	200084	BCM01-J	1001b	0.030 % - View
4	H2	200063	BCM01-J	1001b	0.004 % - View
5	H3	200042	BCM01-J	1001b	0 %

Missing Sensor Calibration

Warning:

If a red X is displayed in the **Cal** column of a magnetic channel, the calibration file for that sensor serial number has not been found

Solution:

Ensure that the calibration files for the sensors used in the recording have been imported into the project

Generic calibration of the sensor type selected will be applied in processing when there is no matching calibration found

- White Noise recordings will not use any calibration compensation for processing

The screenshot shows a software interface with a station list at the top, a map in the middle, and a channel configuration table on the right.

Station List:

Station name	Groups	Filters	Cal
MTU-5C - 10116	None	None	2017
MTU-5C - 10125			✓
MTU-5C - 10127			✓
MTU-5C - 10128			✓
MTU-5D - 10176			✓

Map: Shows a map of the United States with two locations marked: 'Remote' and 'Integration Testing'. A large green circle is centered on 'S1 MTU-5C' at the 'Integration Testing' location.

Channel Configuration Table:

Channel	Sensor	Detected	Serial #	Cal	Polarity	Gain	LPF [Hz]	DC [V]
H1	MTC-155	MTC-155	53094	✓	Inverted	x4	10000	0.0015
H2	MTC-155	MTC-185	57680	✗	Inverted	x4	10000	-0.025
H3	N/A	N/A	N/A	✗	Inverted	N/A	N/A	N/A

No matching calibration found

Bad PNT curve

Problem:

Although the high frequency looks correct, the continuous decimation level is affected by the whole time series.

Solution:

This problem could be caused when something touches the receiver E-line binding post during the recording process.

1. Review the **Time Series** and find the E-line affected.
2. Review the installation and keep cables flat on the ground, not draped over plants or the receiver.

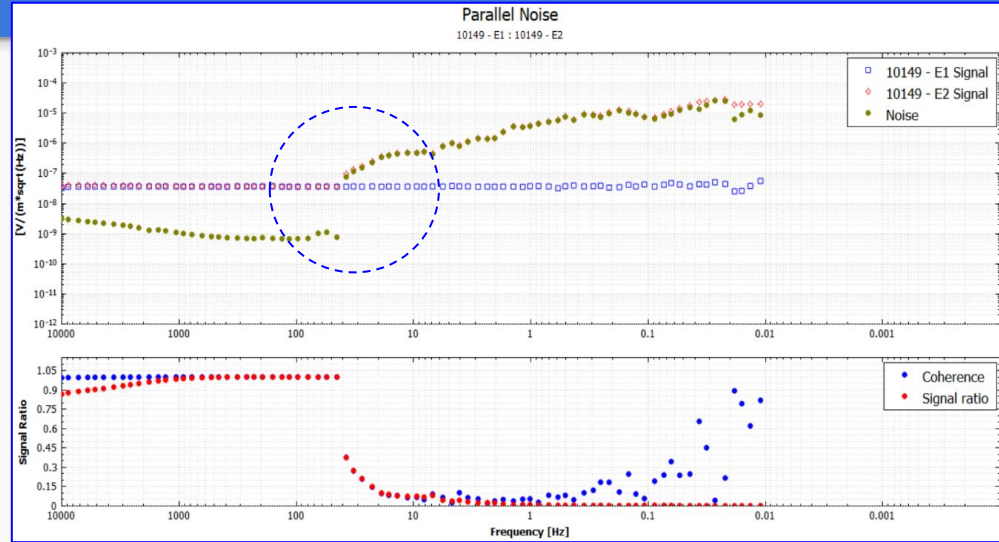

Time Series

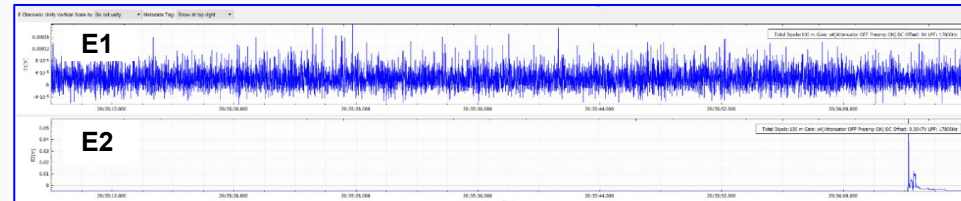



Please check out the [FAQs](#)

<https://phoenixgeophysics.freshdesk.com/>

Or email us at: support@phoenix-geophysics.com